

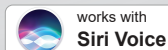

Smart WiFi Water Valve

TLL331501



- 🇬🇧 Installation guide and operation instructions
- 🇷🇴 Ghid de instalare și instrucțiuni de funcționare
- 🇪🇸 Guía de instalación e instrucciones de funcionamiento
- 🇫🇷 Guide d'installation et mode d'emploi
- 🇮🇹 Guida all'installazione e istruzioni per l'uso
- 🇩🇪 Einbauanleitung und Bedienungsanleitung



INTO YOUR FUTURE

Thank you for choosing Tellur products!

To ensure an optimum performance and safety, please read this user manual carefully before using the product. Keep this user manual safe for future references.

1. GENERAL SAFETY INFORMATIONS:

1.1 WARNINGS

- We recommend that the installation be done by qualified personnel.
- Make sure to switch off the water and power supply before installing or maintaining the product!
- Make sure you have prepared the necessary tools suitable for assembly, disassembly.
- The valve size is DN20 (3/4") standard with BSP thread. Check if you have different standard and prepare adapters if needed (not included)
- Make sure that there is at least one control valve before the installation position in the direction of the water flow.
- Respect the technical specifications of the product and do not use it outside the declared operating parameters.

1.2 ATTENTION

- To avoid wiring damage or abrasion, do not expose the wire to edges of metal or other sharp objects.
- Do not install the product in an installation that exceeds the maximum pressure limit, 10 Bar.
- Don't use the product if it is damaged in any way, shape, or form.
- Don't attempt to repair, disassemble, or modify this product.
- Don't place the product near any heat source or in direct sunlight.

1.3 NOTES

- The Smart Valve is powered by DC 5V 2A USB cable. In case of power source cut off, if the valve is in open position, it will close automatically to prevent any leakage.
- In case of power source cut off, using an alternative power source with USB Output, like a portable battery, computer or generator, the valve can be controlled locally through physical button.

1.4 IMPORTANT NOTES ABOUT WIFI SMART CONTROL WITH TELLUR SMART APP

- Make sure you have an active 2.4GHz Wi-Fi internet network, and you have access to Wi-Fi password.
- This device is compatible with 2.4GHz Wi-Fi networks only. 5GHz Wi-Fi is not supported. If you don't have 2.4GHz Wi-Fi network available, check the router settings, contact a specialized technician or the internet provider for support.
- The app does not support Wi-Fi 6 networks with 802.11ax standard. Please set the 2.4GHz Wi-Fi network to 802.11b/g/n.
- No special gateway is required to remotely control the product via Wi-Fi.
- Wi-Fi passwords should not include special characters such as ~!@#\$%^&*().
- Make sure your Wi-Fi internet is stable and the signal is strong enough in the installation location.

2. PRODUCT OVERVIEW

2.1 PRODUCT DIAGRAM

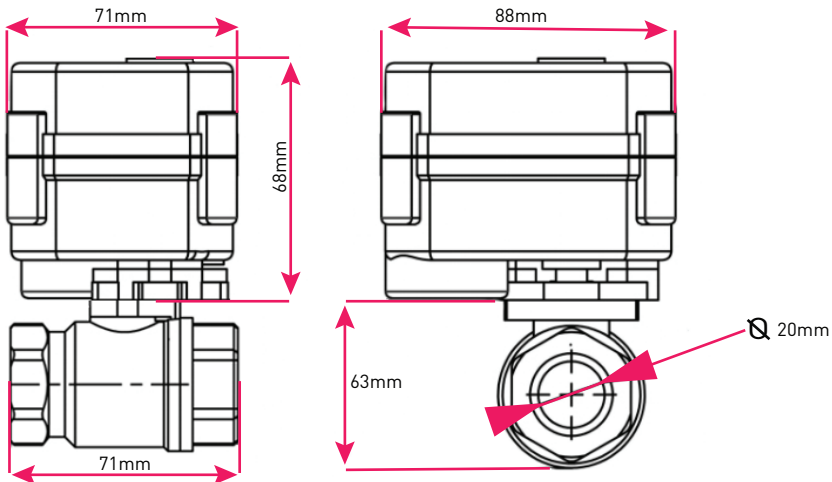

2.2 MAIN FUNCTIONS

- Safe, strong, and reliable construction, made with Stainless Steel for pipe connector and valve, waterproof rating IP67.
- Multipurpose use, home, greenhouse, garden, fire security systems
- Remote Control via the Internet, using Tellur Smart APP
- Voice Control Through Alexa, Google, Siri Shortcuts
- Precise adjustment of the required water flow
- Time-of-use scheduling and automation
- Physical switch for fully open or fully close the valve manually.
- Power failure protection. The valve will close the water flow automatically in case of power supply cut-off.
- USB 5V power supply connector with 1.5 meters long cable. In case of emergencies, it can work with portable power banks or other devices that have USB output.

2.3 IN THE BOX

- Smart Wi-Fi Water Valve
- USB Power cable
- Installation guide and operation instructions

2.4 NOTES

For full technical specifications please check chapter 9

3. PRODUCT INSTALLATION

3.1 WARNING ⚠

Make sure to switch off the water and power supply before installing or maintaining the product!

3.2 PREPARATIONS AND CHECKS BEFORE INSTALLATION

- We recommend that the installation be done by qualified personnel.
- Make sure you have prepared the necessary tools suitable for assembly, disassembly.
- The valve size is DN20 (3/4") standard with BSP thread. Check if you have different standard and prepare adapters if needed (not included)

3.3 INSTALLATION/MOUNTING

- Mount the valve on the required pipe and make sure the connections are secure and there are no water leaks.
- Power the valve to an outlet with a USB port
- Check if the manual button opens and closes the valve properly.

3.4 NOTES

For Troubleshooting please check chapter 8

4. PAIRING THE DEVICE WITH TELLUR SMART APP

4.1 ATTENTION ⚠️

- This device only supports 2.4GHz frequency band router, does not support 5GHz frequency band router.
- Make sure your phone is connected to the 2.4GHz wireless network and you have access to Wi-Fi password before you start the pairing procedure.
- The app doesn't support Wi-Fi 6 networks with 802.11ax standard. Please set the 2.4GHz Wi-Fi network to 802.11b/g/n
- Wi-Fi passwords should not include special characters such as ~!@#\$%^&*().
- Make sure the Wi-Fi signal is strong enough in the area where the device will be installed.

4.2 DOWNLOAD AND INSTALL THE TELLUR SMART APP

Available for either iOS or Android devices.



4.3 CREATE AN ACCOUNT

Once downloaded, the app will ask you to create an account (if you don't have any already). Enter your email, select the country you live in and create a password for your Tellur Smart account.

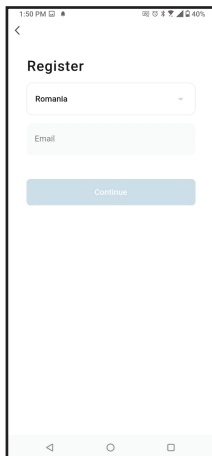

4.4 PRODUCT PAIRING

- Open the Tellur Smart app and click “Add device” or “+” and then select “Industry & Agriculture” -> “Water valve controller (Wi-Fi)”.

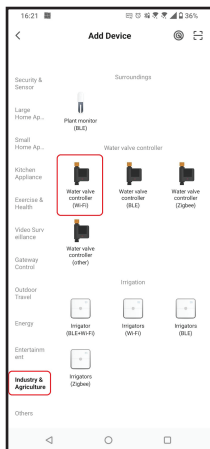
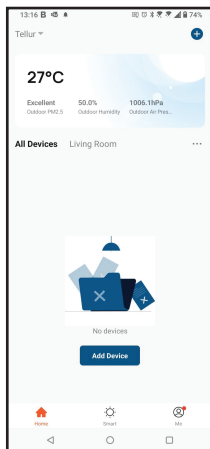

- Power on the valve and wait until the Wi-Fi LED is flashing quickly.
- If the LED doesn't flash, long press the manual switch button for about 5 seconds.
- Select the Wi-Fi network, input your Wi-Fi password and click "Next".
- Confirm the LED is flashing quickly in the app interface.
- Wait for the device to be added automatically. Tap “Done” when finished and the device will appear in your list

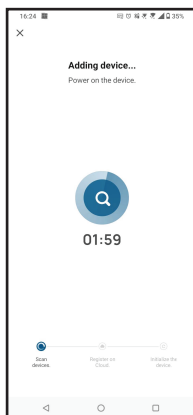
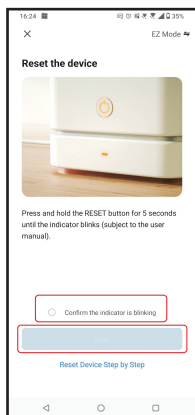

4.5 NOTES

For Troubleshooting please check chapter 8

5. TELLUR SMART APP FEATURES

Main interface



1. Actual percentage of open valve status
2. Set flow rate from 0% to 100%
3. OFF - close the valve to 0%
4. MAX - open the valve to 100%
5. Schedule
6. Countdown

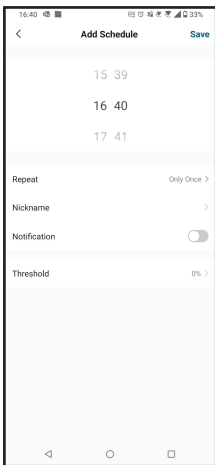

- **Schedule** – You can set how often, how long and at what flow rate should the valve stay open.

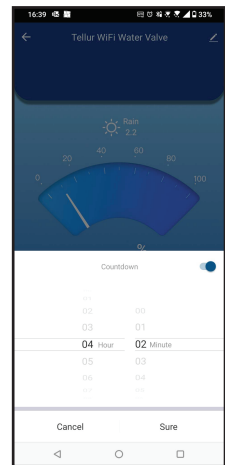

- **Countdown** – You can set a precise amount of time for the valve to stay open.

- **Smart** - Create various automations and scenarios using weather changes, other devices behavior or schedules.

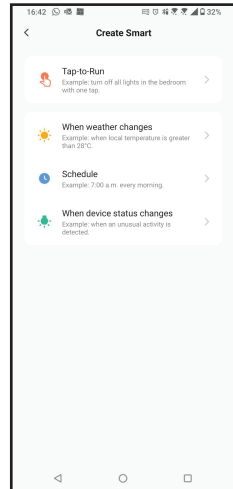
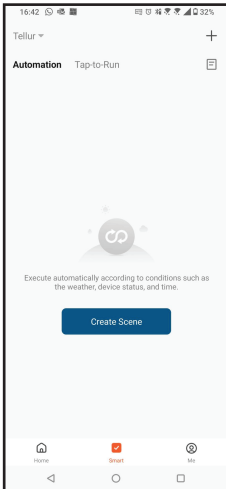

- **Settings** – You can share the device with others, check for firmware updates, rename, remove device, get notification if the device becomes offline.

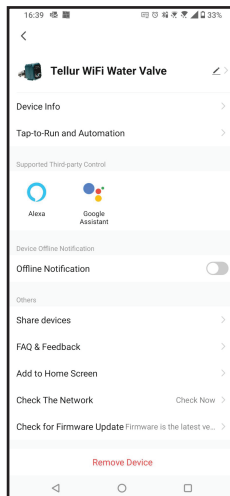

6. Amazon Alexa integration

1. Go to Home menu on Alexa app.
2. Select "Skills" / "Skills & Games".
3. Type Tellur Smart in the search bar.
4. Select Tellur Smart and click "Enable" to activate Tellur Smart.
5. Enter your Tellur Smart account and password. Now you have finished the integration with Alexa.

Tellur Smart app is now skilled with Alexa, and you can vocally control the devices added in Tellur Smart.

Remember - if you rename your smart devices, use a simple name that Alexa can recognize.

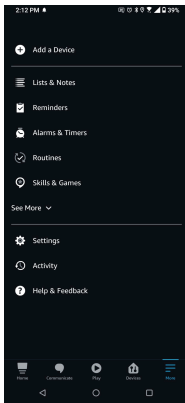

1.

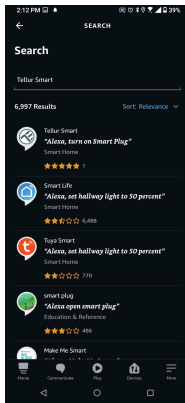

2.

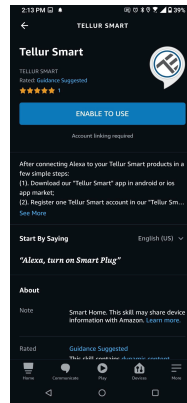

3.

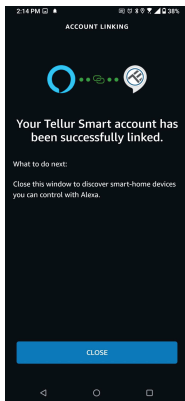

4.

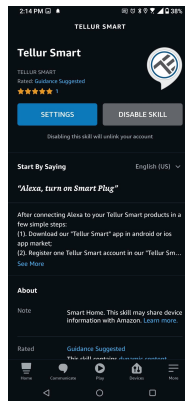

5.

To control your smart devices through Alexa, use simple and concise voice commands. Here is an example for bedroom lighting:

“Alexa, turn off bedroom light”

“Alexa, turn on bedroom light”

“Alexa, dim bedroom light”

“Alexa, set bedroom light to red”

7. Google Home integration

Before using Google Home to control your devices, make sure you meet the following conditions:

- You have a Google Home device or an Android device with Google Assistant.
- You have the newest version of Google Home app.
- You have the newest version of Google app (Android only).
- The device display language is set to English US.
- You have the Tellur Smart app and a related account.

Add devices in Tellur Smart app (refer to app instructions) – you can skip this part if you have already added some devices to your Tellur Smart account. Make sure your devices' names are easily recognizable.

Link account in Home Control

1. Go to Google Home's homepage and tap "+".

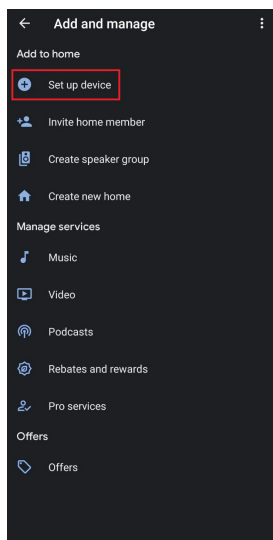
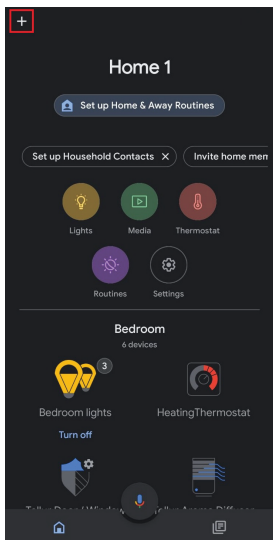

7.2. Hit the "Add new" button, enter Tellur Smart in the search bar, and select the app from the list. Next, select your Tellur Smart account's region, enter your Tellur Smart account and password, and tap "Link now". After you assign rooms for devices, your devices will be listed in the Home Control page.

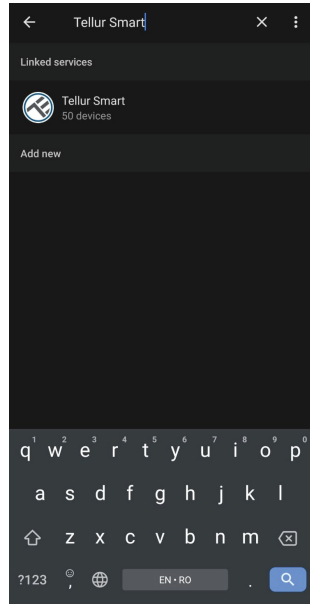
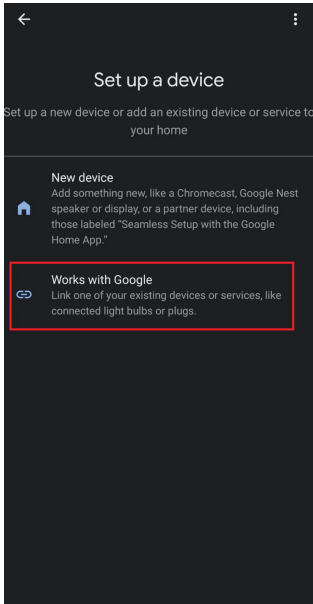

Now you can control your smart devices through Google Home. Take bedroom light as example – the supported voice commands are as below:

- Ok Google, turn on/off bedroom light.
- Ok Google, set bedroom light to 50 percent.
- Ok Google, brighten bedroom light.
- Ok Google, dim bedroom light.
- Ok Google, set bedroom light to red.

8. TROUBLESHOOTING

- Make sure the device is powered on and the connection to power supply is good.
- If there is a water leakage, first close the water and power supply before inspecting the valve.
- Check the Wi-Fi connection of your phone.
- Check if the device is in pairing mode. Reset your smart device to enter pairing mode.
- Check router or related: If you use a dual-band router, select the 2.4GHz network to add the device. You also need to enable the router's broadcasting function. Set encryption method as WPA2-PSK and authorization type as AES or set both on "auto".
- Check if the Wi-Fi signal is strong enough. To maintain the signal strong, keep your router and the smart device as close as possible.
- Wireless mode should be 802.11.b/g/n (Wi-Fi 6 protocol 802.11ax is not supported)
- Make sure you don't exceed the maximum number of registered devices supported by the app (150).
- Check if the router's MAC filtering function is enabled. If so, remove the device from the filter list and make sure the router is not prohibiting the device connection.
- Make sure the Wi-Fi password entered in the app is correct.

Can I control the device with 3G/4G/5G network?

When adding the device for the first time, the device and the phone need to be connected to the same Wi-Fi network. Once the device has been successfully paired with the Tellur Smart app, you can remotely control it via 3G/4G/5G networks.

How can I share my device with family?

Open Tellur Smart app, go to "Profile" -> "Device sharing" -> "Sharing sent", tap "Add sharing" and share the device with the added family members.

Notice - users must install the Tellur Smart app on their device to see shared devices.

How can I manage the devices shared by others?

Open App, go to "Profile" > "Device Sharing" > "Sharing Received", then you can find the devices shared by other users. To delete a shared device, swipe left.

9. TECHNICAL SPECIFICATIONS

EN

Input power:	USB DC 5V/2A (AC adapter not included)
Cable length:	1.5-meter USB to 2pin waterproof socket connector
Pipe connector material:	SS304 (Stainless Steel 304)
Valve size:	DN20 (3/4") BSP thread
Max pressure:	1.0 Mpa (10 Bar)
Waterproof rating:	IP67
Manual operation:	Fully open / fully closed by manual switch
Features:	APP Remote operation, Flow size control, Schedule and Countdown, Fully integrated in Tellur Smart ecosystem
Power failure protection:	Automatically close if unexpected power cut off
Wireless frequency:	2.4GHz
WiFi standard:	IEEE 802.11b/g/n (WiFi-6 not supported)
Security:	WEP, WPA/WPA2, WPA/WPA2 PSK (AES), WPA3
Encryption type:	WEP/TKIP/AES
APP Name:	Tellur Smart
APP Compatibility:	Devices with Android 4.2 / iOS 8 or more recently
Google Home:	Compatible
Amazon Alexa:	Compatible
Siri Shortcuts:	Compatible
Suitable for:	Indoor use
Working condition temperature:	-30°C ~ 60°C
Package include:	Smart Wi-Fi Water Valve USB Power cable

Disposal and recycling information



The crossed-out wheeled-bin symbol on your product, battery, literature or packaging reminds you that all electronic products and batteries must be taken to separate waste collection points at the end of their working lives; they must not be disposed of in the normal waste stream with household garbage. It is the responsibility of the user to dispose of the equipment using a designated collection point or service for separate recycling of electrical and electronic equipment waste (WEEE) and batteries according to local laws. Proper collection and recycling of your equipment helps ensure EEE waste is recycled in a manner that conserves valuable materials and protects human health and the environment. Improper handling, accidental breakage, damage, and/or improper recycling at the end of its life may be harmful for health and environment.